

Powder Whiteness Tester C-130



User Manual

Safety Precautions

If this whiteness tester is not used according to the safety precautions, accidents can occur which may cause damage to the instrument, the operator or other items. Our design has included substantial consideration for product safety but please read the precautions contained in this user manual and use the product correctly.

- **Please obey all safety precautions**

Please thoroughly read the precautions included in the user manual.

- **Please do not use this product if it is not working properly**

If the product should break or malfunction, please contact the retail outlet where you purchased the product, or our company directly.

- **Interpreting warning symbols**

The following symbol is displayed in this user manual to help prevent accidents from occurring due to the incorrect use of this device.



Caution

This symbol indicates that, if ignored, and if the device is incorrectly used, physical damage or user injury may occur.

Table of Contents

| | |
|---|-----------|
| 1. Measurement Principles and Characteristics..... | 4 |
| 2. Specifications..... | 5 |
| 3. Part Names & Accessories..... | 6 |
| 4. Description of Operation Keys..... | 7 |
| 5. Preparing for Measurement..... | 8 |
| 6. Measurement | 9 |
| 7. How to Make User Calibration Curve..... | 12 |
| 8. Maintenance & Other Functions | 15 |

1. Measurement Principles and Characteristics

■ Measurement Principles

This device measures powder whiteness according to our own uniquely developed standards. It measures reflectivity and utilizes two blue LEDs as its light source. The light from the blue LEDs is passed through a diffuser panel and shined onto the sample surface at 45 degree angles from both the left and right. A photo diode measures the amount of reflected light. The whiter the sample, the more light is reflected back and detected and thus a higher measurement value is registered. The LEDs are a blue color with a 466nm center wavelength. They are adjusted to provide a similar measurement that the previous model (C-100) created when used with it's blue filter. In addition to having a starch calibration curve built in as the base calibration curve, a function allowing the user to set their own calibration curves is also included, making it possible to measure the whiteness of a variety of powders.

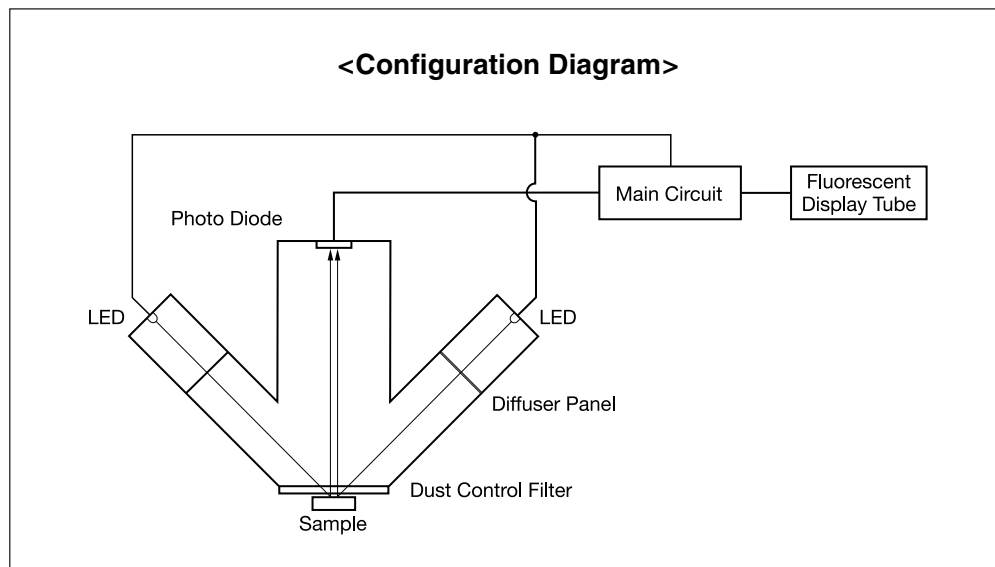

■ Characteristics

The new C-130 model is smaller and more compact than our previous C-100 model. Furthermore, using blue LED light sources allow for a longer light source lifetime reduced power consumption and reduced heat generation. In addition, the required sample size has been greatly reduced. Using starch as an example, about 13.5g of sample was required in the C-100. The C-130 only requires approximately 5.5g of starch, Not only has ease of packing of the sample been improved, but the amount of time spent preparing for the measurement has been reduced. Finally, sensitivity calibration when the device is turned on has been reduced, allowing measurements to begin much faster than with previous models.

2. Specifications

| | |
|-----------------------------------|--|
| Measurement method | : Reflectivity measurement |
| Accepted samples | : Various types of powder (Starch, Wheat flour, Tapioca flour, Cement etc.) *(starch is the base calibration curve, but the user can set their own calibrations) |
| Measured item | : Whiteness (Different from JIS definition) It is different from "HAKU SHO KUDO" which is defined in JIS (JIS : Japan Industrial Standard) |
| Measurement range | : 5.0-120.0 |
| Resolution | : 0.1 |
| Display method | : Fluorescent display tube |
| Functions | : User calibration curve, sensitivity adjustment notification, average, printer output |
| Usable temperature/humidity range | : Temperature 5-40°C / Humidity 30-85% (non-condensing) |
| Light source | : Blue LED |
| External output | : RS-232C |
| Power source | : AC 100V-120V (50/60Hz) : Power cord A (Flat blade attachment plug, Type A-1) AC 200V-240V (50/60Hz) : Power cord B (Round pin attachment plug, Type C-4) |
| Power consumption (maximum) | : 16W (AC100V-120V / AC200-240V) |
| Power consumption (normal) | : 4W (AC100V-120V / AC200-240V) |
| Dimensions | : 375 (W) x 220 (D) x 250 (H) mm |
| Weight | : 7.0kg |
| Included Parts | : Whiteness standard plate, Whiteness standard plate case, Sample platter x 5, Sample platter holder, Spoon with spatula, Brush, cleaning brush, Blower brush, Glass wiper, Replacement fuse, Power cord, Power plug conversion adapter, Simple guide to sampling, User manual |
| Optional Parts | : Printer VZ-330, printer cable VZC-14 |

3. Part Names & Accessories

<Main Unit>

<Front Side>

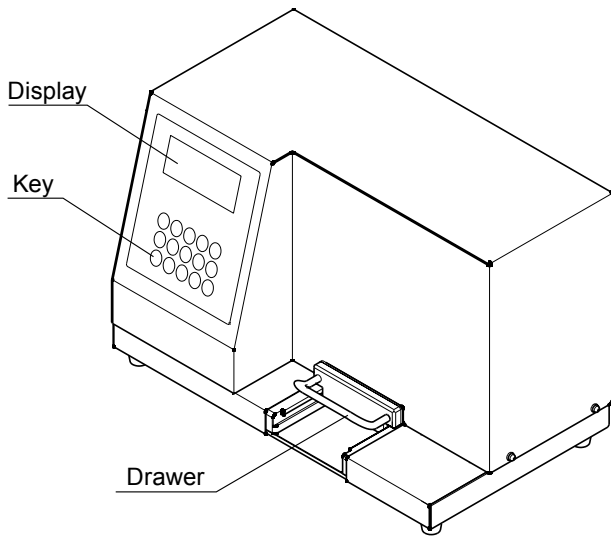

<Rear Side>

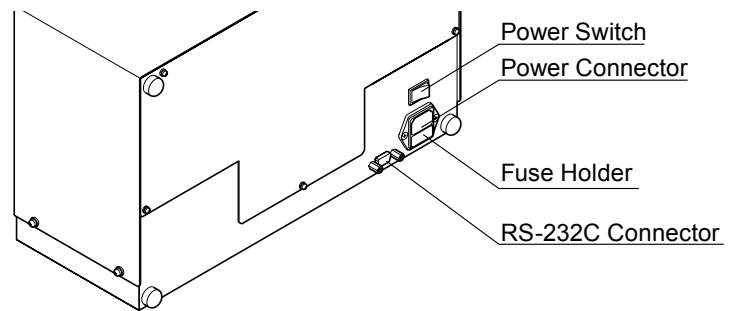

<Bottom>

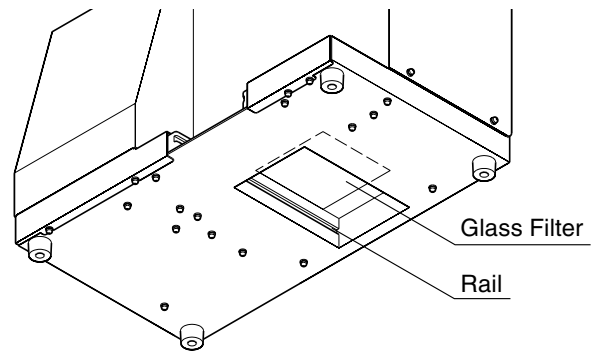

<Included Parts – with part numbers>

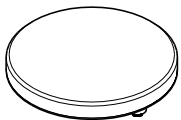

Whiteness Standard Plate
C-130-01

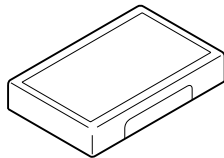

Whiteness Standard Plate Case
C-130-02

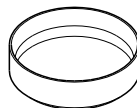

Sample Platter x 5
C-130-03

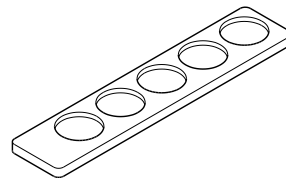

Sample Platter Holder
C-130-04

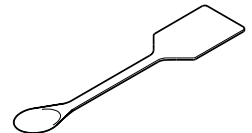

Spoon With Spatula
C-130-05

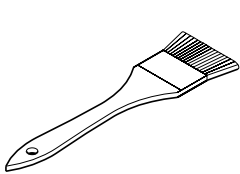

Brush
C-130-06

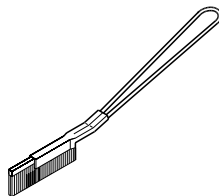

Cleaning Brush
C-130-07

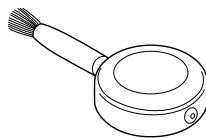

Blower Brush
C-130-08

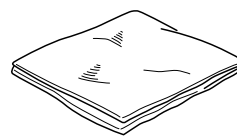

Glass Wiper
C-130-09



Replacement Fuse
C-130-10

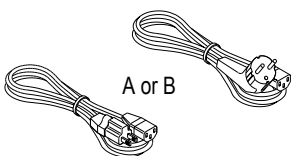

Power Cord A
(100V-120V)
C-130-11-A

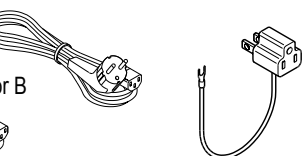

Power Cord B
(220V-240V)
C-130-11-B

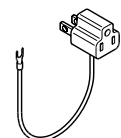

Power Plug
Conversion Adapter
C-130-12

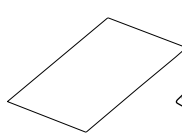

Simple Guide to Sampling
C-130-13

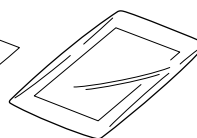

User Manual
C-130-14

<Optional Parts>

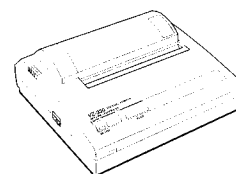

Printer VZ-330
C-130-15

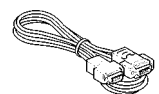

Printer Connector Cable VZC-14
C-130-16

(It is attached for Power cord A)
(for 100V-120V uses) only.)

4. Description of Operation Keys

<Operation panel>

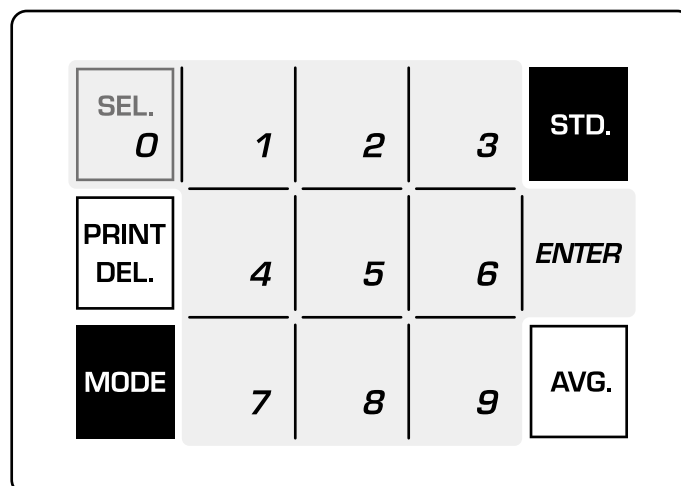

| Key | Function |
|--|--|
| <div style="border: 1px solid black; padding: 2px; width: 40px; margin: 0 auto;">SEL. 0</div> | Select calibration curve and input numerical value (0). |
| <div style="display: flex; justify-content: space-around; align-items: center;"> <div style="border: 1px solid black; padding: 2px; width: 30px; height: 30px; display: flex; align-items: center; justify-content: center;">1</div> ~ <div style="border: 1px solid black; padding: 2px; width: 30px; height: 30px; display: flex; align-items: center; justify-content: center;">9</div> </div> | Used to input numerical values. |
| <div style="border: 1px solid black; padding: 2px; width: 40px; margin: 0 auto;">PRINT DEL.</div> | Turn printer on/off. When changing numerical values, use this key as the backspace key. |
| <div style="background-color: black; color: white; padding: 5px; width: 40px; margin: 0 auto;">MODE</div> | Switch between measurement mode and standard plate check mode. <div style="border: 1px solid black; padding: 2px; display: inline-block; margin-bottom: 5px;">Measurement mode</div> Use for normal sample measurements and when creating a user calibration curve. <div style="border: 1px solid black; padding: 2px; display: inline-block; margin-top: 5px;">Standard plate check mode</div> Use when adjusting whiteness standard plate for sensitivity. |
| <div style="background-color: black; color: white; padding: 5px; width: 40px; margin: 0 auto;">STD.</div> | Used for sensitivity calibration. |
| <div style="border: 1px solid black; padding: 2px; width: 40px; margin: 0 auto;">ENTER</div> | Used to confirm numerical value input. |
| <div style="border: 1px solid black; padding: 2px; width: 40px; margin: 0 auto;">AVG.</div> | Used to display the average of measured values. |

5. Preparing for Measurement

5-1. Connecting the power cord

[Caution] Power supply voltage may be different when using this product in other countries. Please only use a power cord designed for your country.

- (1) Insert the power cord into the power supply connector on the rear of the main unit.
- (2) If the power supply is a three-prong plug 100V-120V outlet, insert the power cord into VAC outlet. (See the right figure and in case of 100V-120V use with the blade plug connector). Connect the included power plug conversion adapter into the power cord first, then plug the cord into a 100V-120V power outlet. Next, connect the ground wire on the power cord to the ground.

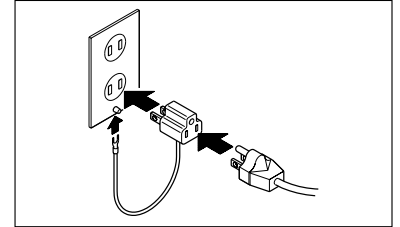

[Caution] If 200V-240V outlet is used, power cord B should be used.

[Caution] If the power supply is 200V-240V with a flat blade plug, the conversion adapter should be prepared by yourself.

[Caution] If the power supply is 100V-120V with a round pin plug, the conversion adapter should be prepared by yourself.

5-2. Whiteness standard plate set

As shown in the diagram, insert the whiteness standard plate into the drawer of the main unit and close the drawer.

[Note] To ensure proper placement of the whiteness standard plate, there is a pin that protrudes from the bottom. Make sure the pin goes into the hole in the drawer.

[Note] Be sure not to touch or scratch the hole on whiteness standard plate. If it gets dirty, clean it with the glass cleaner.

[Note] Keep the whiteness standard plate in the case when not in use. Use the magnetic bottom of the case to hang it in a convenient place (or on the instrument).

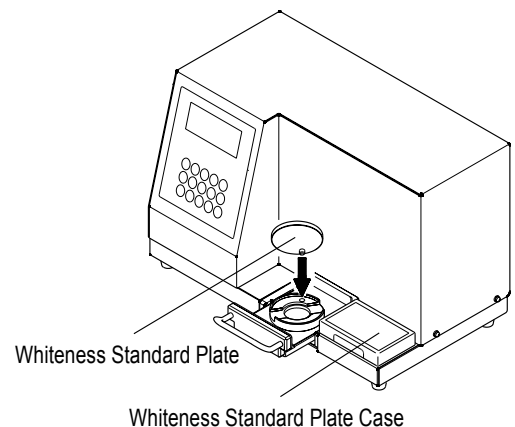

5-3. Starting up the main unit

- (1) Turn the power switch located on the back of the main unit to ON..
- (2) [WARMING-UP] is displayed. Dots will flash for about 20 seconds.

[Note] If the whiteness standard plate is incorrectly placed, when you turn on the power switch, [Insert STD] or [Error 01 Leak] will display. If this occurs, correctly insert the whiteness standard plate into the drawer (see 5-2).

- (3) When powering up, if the machine is set to standard plate check mode, the whiteness standard plate value will display.
- (4) If you press the **MODE** key, it will change to measurement mode and 'CHECK STD' will disappear.
- (5) Remove the whiteness standard plate.

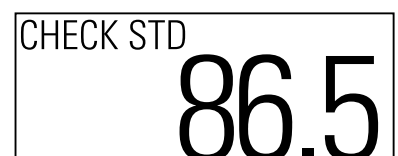
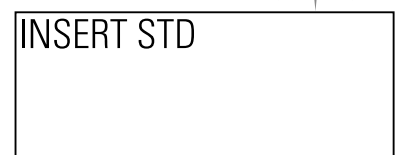

[Example]
When a whiteness standard plate value of 86.5 is selected.

6. Measurement

[Caution] Before performing any measurements, use the glass wiper to clean the glass filter of the main unit (refer to 8.1).

6-1. How to pack the sample

(see the separate 'Simple Guide to Sampling')

[Note] The following is the standard measurement method for starch. Different packing methods will apply to samples with larger diameters, viscosity, moisture, runny sample, etc.

(1) Heap the sample onto the sample platter.



(2) Use the spoon with spatula to pack down the sample.

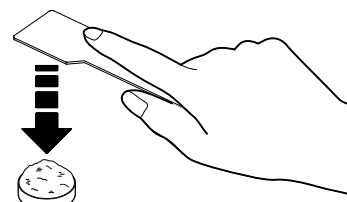

(3) Use the spoon with spatula to level off the sample to the height of the edge of the sample platter.

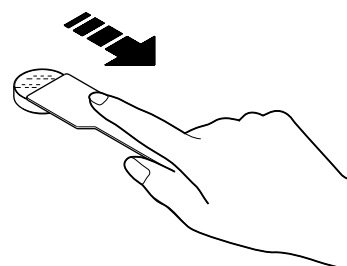

[Note] An accurate measurement cannot be taken if there are cracks or lumps in the surface of the sample. Use the spatula to make the surface as flat and smooth as possible.

[Note] When the surface of the sample to be measured is as flat as possible, the measurement will be very accurate.

[Note] If powder sticks to the outside or bottom of the sample platter, clean it with the brush. Powder stuck to the sample platter may cause it to tilt, resulting in the measurement not being accurate. While cleaning the sample platter, the spatula may be used to hold down the sample and keep the surface flat and smooth.

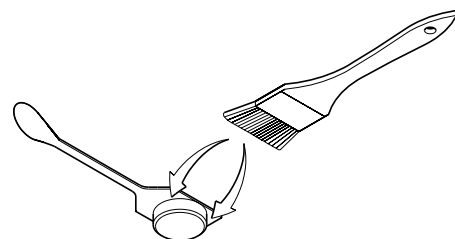

[Note] Depending on the sample, contact with the air may cause drying or an increase in moisture content. When handling such samples, it is necessary to move quickly to the next operation after packing down the sample.

[Note] If several samples are measuring at the same time, Sample Platter Holder is useful in this purpose.

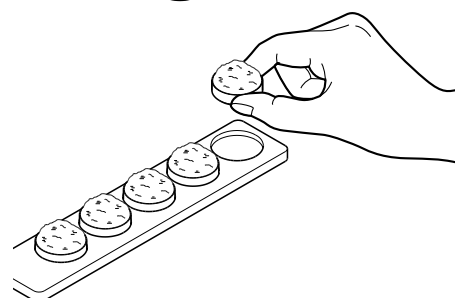

6-2. Setting the sample platter

Open the drawer and place the sample platter inside the drawer.

[Note] If there are any contaminants stuck in the area where you place the sample platter or drawer, the platter will tilt and it will not be possible to get an accurate measurement. Always keep the inside of the drawer clean.

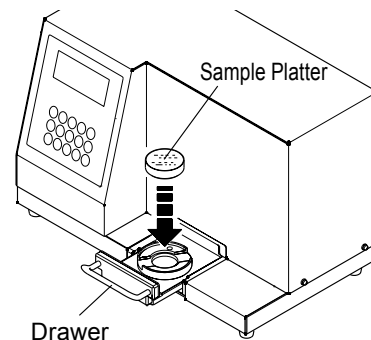

6-3. Closing the drawer

Slowly, completely close the drawer.

[Note] Light entering through any gaps may make accurate readings impossible.

[Note] Impacts while closing the drawer may cause cracks in the sample surface, leading to inaccurate measurements. Please slowly close the drawer.

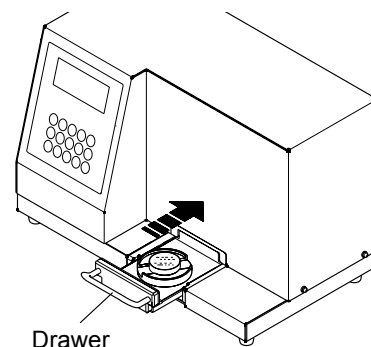

6-4. Measurement

After closing the drawer, the calibration curve number, the number of the measurement and whiteness value will be displayed automatically.



[Note] If the reading is outside of the measurement range, UNDER or OVER will be displayed.

■ Selecting the Calibration Curve

The C-130 can have up to ten calibration curves. [01] is for the base calibration curve, and [02-10] provide for nine additional customer calibrations that can be stored and later retrieved.

[Note] The factory setting is the base calibration curve [01].

[Note] Please refer to [7. How to Make a User Calibration Curve] for information on how to register a user calibration curve.

- (1) Set the whiteness standard plate.
- (2) In Measurement Mode, use the  key to select the calibration curve input mode.
- (3) The instrument restarts after you input your desired calibration curve number and press the  key.
- (4) The main unit startup procedure follows the same sequence (refer to 5-3) and returns to measurement mode. At the time of measurement, the calibration curve number will be displayed.

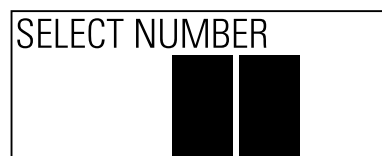
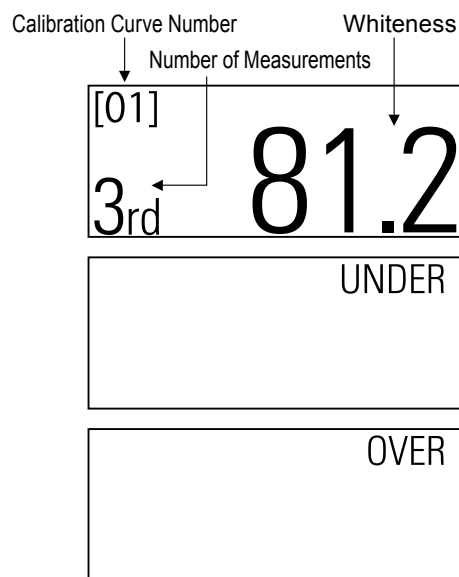

■ Average Value

This device can display the average value for 2-9 measurements. After measuring 2-9 times, press the  key and the average value, in addition to the number of measurements, will display. Displaying the average value deletes all previous values and makes the next measurement the first measurement of the next set.

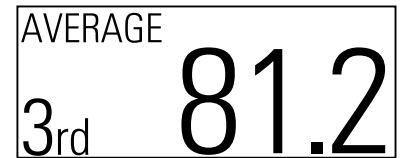

AVERAGE
3rd 81.2



The number of measurements is displayed after each measurement. However, the display will show 1 in the following situations:

- (1) After pressing the  key
- (2) After the number of measurements has reached 9
- (3) After changing to Standard Plate Check Mode
- (4) After changing the calibration curve number

6-5. Adjusting for Sensitivity

After performing measurements for a long period of time, the sensitivity of the device may need to be re-calibrated. Therefore, the sensitivity must be periodically checked.

[Caution] If a sensitivity adjustment is required, [C] will be displayed in the upper right corner of the display.

- (1) Press the  key, and [CHECK STD] will display. You can then switch to the Standard Plate Check Mode.
- (2) The value of the whiteness standard plate will be measured if you place the whiteness standard plate and close the drawer.
- (3) Sensitivity is misaligned when the measured value and the value recorded on the whiteness standard plate do not match. While the whiteness standard plate is still in the machine, press the  key and the sensitivity will be automatically adjusted.
- (4) Press the  key to switch from Standard Plate Check Mode back to Measurement Mode. [CHECK STD] will disappear.
- (5) Remove the whiteness standard plate.

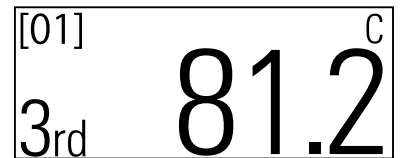

[01]
3rd 81.2^C

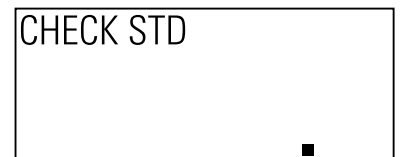

CHECK STD

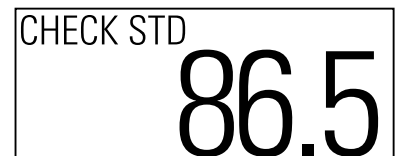

CHECK STD
86.5

[Note] The whiteness standard plate can be measured during Measurement Mode. While the reading may be different during Standard Plate Check Mode, this is not unusual.

[Note] For accurate whiteness measurements, it is important to regularly adjust instrument sensitivity (the brightness of light). You are more likely to see the [C] indicator in the top right of the display either immediately after startup or when substantial humidity changes alter the light transmission near the LEDs.

7. How to Make a User Calibration Curve

7-1. About user calibration curves

For users of previous models (C-100), measurement values compared to those of previous models may be different when measuring samples other than starch. Additionally, there may be a need for a different calibration curve than the factory standard provided, depending on the measurement requirements (e.g., customer internal standards). In such cases, it is possible to calculate the reading by creating a user calibration curve.

[Note] You can register up to 9 user calibrations from [02] to [10].

<Example : User calibratur Curve>

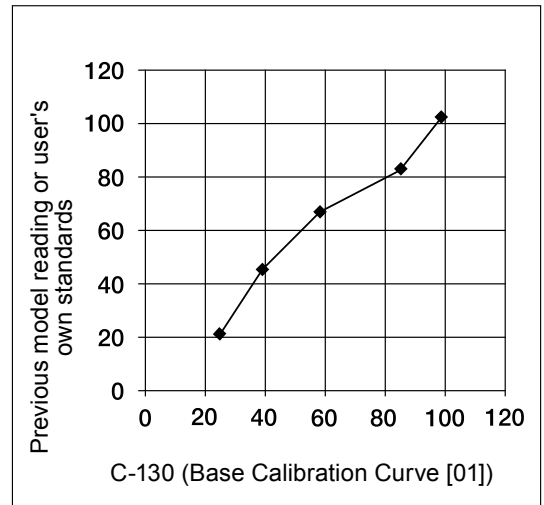

7-2. Creating a calibration curve

- (1) Sample preparation
Prepare 5 samples of various whiteness levels. Samples should include the upper and lower limits of the whiteness values you intend to measure. As an example, if you wish to measure whiteness between 40 and 95, you should include a sample with a whiteness of approximately 40 and a sample with a whiteness of approximately 95.
- (2) Reading the sample
Read the prepared sample using the machine's by Measurement Mode (Base Calibration Curve [01]), Measure the sample using the previous instrument or the user's standard method.
- (3) Record the sample readings per Table 1.
(Please copy and use the Creating a Calibration Curve Table, P.18)

<Table-1>

◆ Calibration Curve (CC) Number: 03
 ◆ Calibration Curve Name: Talc Calibration Curve
 ◆ Sample Name: Talc

| | C-130 | Reading from previous instrument or according to user standard method |
|----------|----------|---|
| Sample ① | * 1 24.7 | 21.1 |
| Sample ② | 39.1 | 45.4 |
| Sample ③ | 58.5 | 67.2 |
| Sample ④ | 85.2 | 82.9 |
| Sample ⑤ | 98.7 | 102.4 |

Data should be entered from *1, and then entered as directed by the allows.



Caution

[Caution] When making the table, rank the whiteness values of 130's should be from smallest to largest.

[Note] At least two samples should be used when creating a calibration curve. If less than five samples are used, repeat the largest value for the remaining items. As an example, when three samples are used, sample three values should be repeated for sample four and five in both columns.

7-3. Input the calibration curve

[Example]

Input the data from Table 1 into Calibration Curve 03

[Note] User calibration curves can be registered in nine locations, from [02] to [10].

[Note] Use the number keys to input numeric values. If the whiteness value to be input is less than a 3-digit number, place a zero [0] at the beginning of the number and then input.

[Note] If you make an error while inputting, press the  key and re-input the value.

- (1) After inserting the Whiteness Standard Plate, turn on the power using the switch on the back panel of the main unit.
- (2) Shortly after [WARMING-UP] is shown on the display, press the  while decimal point is flashing.



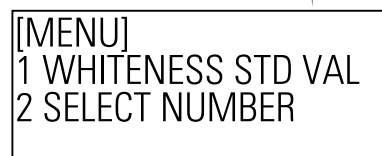

- (3) The display will change to the menu screen.

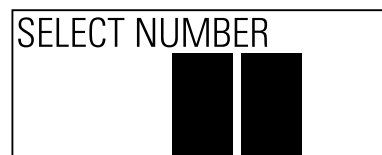

- (4) Press  to switch to the calibration curve number input screen.



- (5) Using keys  to , select the calibration numbers into [02] to [10], then press  to finish. In our example, the data is input to [03].



[Note] [01] is reserved for the base calibration curve and cannot be used for user calibrations.

- (6) Display of calibration curve data

[Note] Calibration curve data is displayed in 2 stages. First, the bottom 3 whiteness values are displayed (1~3), and then after pressing the  key, the next 2 whiteness values are displayed (4~5).

| [03] | C-130 | USER |
|------|-------|------|
| 1 | 60.0 | 60.0 |
| 2 | 70.0 | 70.0 |
| 3 | 80.0 | 80.0 |

[Note] The values shown in the [C-130] column are the measurements in the base calibration curve [01]. The values shown in the [USER] column are the values input by the user. Before calibration, both the [C-130] and [USER] values are the same.

| [03] | C-130 | USER |
|------|-------|------|
| 4 | 90.0 | 90.0 |
| 5 | 99.0 | 99.0 |

- (7) Press  to display the calibration curve input screen.

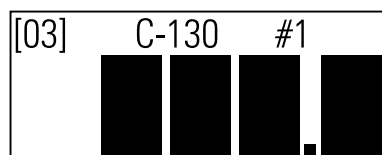

[Procedure 1]

Input C-130's value in Base Calibration Curve [01]

This example shows how to input Sample (1) [24.7].

Press these numbers in the order shown: → → → . When you press , the display changes from [C-130] to [USER] to confirm the input.

[Note] When [C-130] is displayed, input the [C-130 base calibration curve [01] value]. When [USER] is displayed, input the [User Standard value].

[Note] The [#1] in the upper right corner indicates the sample number. As you continue inputting, this will change from [#2] to [#5].

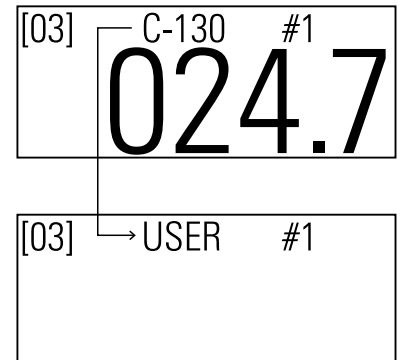

[Procedure 2]

Input user standard values

This example shows how to input Sample (1) [21.1].

Press these numbers in the order shown: → → → . Press to confirm Sample (1). The display will change from [USER] to [C-130], and the upper right number will change from [#1] to [#2].

Repeat [Procedure 1] and [Procedure 2] to input Samples (2) to (5). Once you have input Sample (5), press to complete the calibration curve input operation.

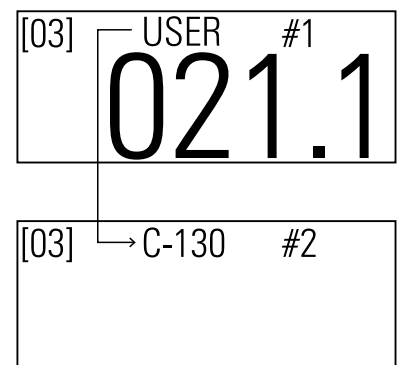

[Procedure 3]

Confirming input calibration data

Calibration curve data is displayed in 2 stages. First, the bottom 3 whiteness values are displayed and then after pressing the key, the next 2 whiteness values are displayed. The confirmation operation is complete if the input values are correct.

[Note] If an error is made during input, press to return to the calibration curve input screen.

Press to restart the unit and begin normal operations. (Press refer to 5-3 [Starting up the main unit])

[Note] If a different calibration curve is input into a curve slot that has already been registered, the previous input will be deleted and overwritten with the new information. We recommend keeping a printed copy of previously generated calibration curve data.

| [03] | C-130 | USER |
|------|-------|------|
| 1 | 24.7 | 21.1 |
| 2 | 39.1 | 45.4 |
| 3 | 58.5 | 67.2 |

| [03] | C-130 | USER |
|------|-------|-------|
| 4 | 85.2 | 82.9 |
| 5 | 98.7 | 102.4 |

8. Maintenance & Other Functions

8-1. Cleaning the main unit glass filter and drawer rails

If the main unit glass filter is dirty, accurate readings are not possible. Also, contaminants on the drawer rails will cause the drawer to slide unevenly. Both areas should be regularly cleaned.

- (1) Unplug the power cord.
- (2) Turn over the main unit.

[Note] Always remove the drawer before turning over the main unit. Turning over the main unit while the whiteness standard plate and sample platter are still inside may cause the drawer to jam.

- (3) Clean the glass filter.
Clean the drawer rails with cleaning brush (C-130-07).



Caution

There is a ridge around a section of the glass filter on the bottom of the main unit. Be very careful not to damage the ridge.

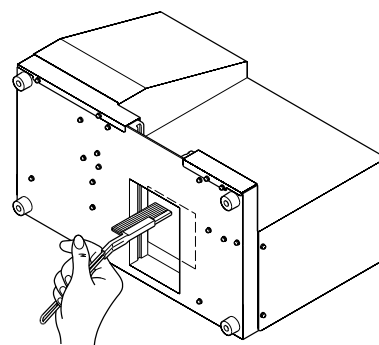

8-2. Input the whiteness standard plate value

[Note] This process is necessary when exchanging the whiteness standard plate.

- (1) If the machine is on, turn it off.
- (2) Place the whiteness standard plate into the main unit.
- (3) Shortly after [WARMING-UP] is shown on the display, press the **STD** while decimal point is flashing.
- (4) The display will change to the menu screen.
- (5) Press **1** to display [STD].
- (6) Input the 3-digit number on the whiteness standard plate and press **ENTER**.

[Note] If an input error is made, press **PRINT DEL** to go back.

[Note] The input range is 80.0 to 99.9.

- (7) [WARMING-UP] will display followed momentarily by the value of the whiteness standard plate. Once it is displayed, press the **MODE** key to switch to the measurement mode and remove the whiteness standard plate.

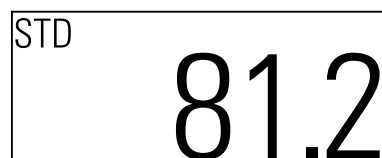
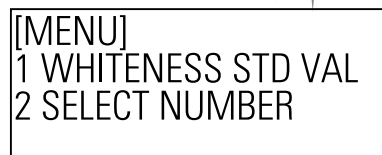

8-3. Fuse replacement

- (1) Turn off the power and remove the power cord.
- (2) The fuse holder is located at the rear of the main unit. Insert a flathead screwdriver into the upper side of the fuse holder and pull out.
- (3) Remove the fuse from the fuse holder to check if it is blown (burned).
- (4) Return the fuse holder if it is not blown. If it is, replace the fuse (120V, 3.15A).
- (5) Return the fuse holder into the main unit.
- (6) Reconnect the power cord.

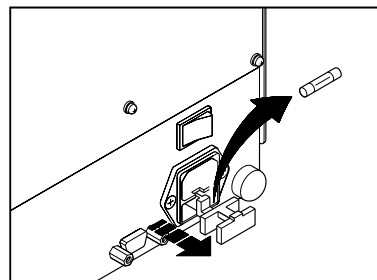
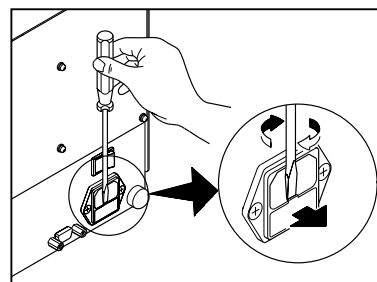

[Note] If the fuse blows after replacing it, the machine may be malfunctioning, and should be inspected and repaired. Contact us or the local agent.

8-4. Output to printer (optional)

By connecting an optional printer, it is possible to print out measurement data and other details.

- (1) Configure the settings for the printer (VZ-330) and then connect it to the C130 using the printer cable (VZC-14).

[Note] Refer to the printer's user manual for instructions on how to connect the printer.

- (2) Press [ON/OFF] to switch to the device's print function. The printer is ON when [PRINT] is displayed after pressing . [NO PRINT] indicates that the printer is OFF.

- (3) When the printer is ON, readings for measurement periods as well as the reading after the  key has been pressed can be printed.

[Note] Measurement results that are outside of the measurement range cannot be printed.

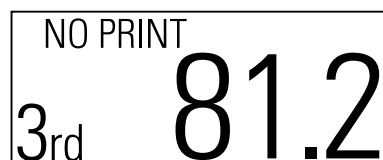
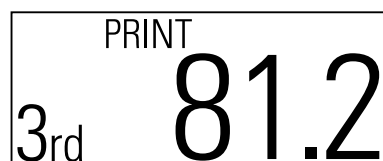

<Printout example>

| | |
|------------------------------|-------|
| WHITENESS TESTER Model C-130 | |
| Calibration | No.01 |
| TIMES | |
| 1 | 83.2 |
| 2 | 83.4 |
| 3 | 82.9 |
| 4 | 83.1 |
| 5 | 83.2 |
| AVERAGE | 83.2 |

8-5. RS-232C Output

(1) RS-232C output interface specifications

- Transmission format : Asynchronous, send-only
- Signal format : Baud rate : 2400bps
 Data bit length : 8-bit
 Parity : Non
 Stop byte : 1 byte
 Code : ASCII

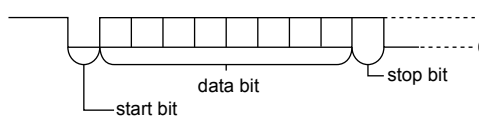

(2) C-130 and RS-232C cable connection

- Printer VZ-330 (for use with VZC-14 cable)



8-6. Error display

If an error occurs with this instrument, an error number and message will be displayed.

| Display | Cause | Troubleshooting |
|----------------------|--|--|
| ERROR 01 LEAK | Electrical circuit malfunction | Needs repair |
| ERROR 02 DARK | No whiteness standard plate has been inserted when attempting to perform a sensitivity adjustment. | Insert the whiteness standard plate and repeat the sensitivity adjustment process. |
| | Electrical circuit malfunction | Needs repair |
| ERROR 03 LED VOLTAGE | Electrical circuit malfunction | Needs repair |
| ERROR 04 MEMORY | Electrical circuit malfunction | Needs repair |

■ Calibration curve number :

■ Calibration curve name :

■ Sample name :

| | C-130 Base Calibration Curve [01] | Reading from Previous Machine or User Standard Method |
|----------|--------------------------------------|--|
| Sample ① | | |
| Sample ② | | |
| Sample ③ | | |
| Sample ④ | | |
| Sample ⑤ | | |

■ Calibration curve number :

■ Calibration curve name :

■ Sample name :

| | C-130 Base Calibration Curve [01] | Reading from Previous Machine or User Standard Method |
|----------|--------------------------------------|--|
| Sample ① | | |
| Sample ② | | |
| Sample ③ | | |
| Sample ④ | | |
| Sample ⑤ | | |

Notes

- Copying some or all of the contents of this user manual without prior written consent is strictly prohibited.
- The contents of this user manual may be changed at any time in the future without any prior notice.
- The appearance and/or representations of the products and parts depicted in this user manual may not appear exactly as their actual counterparts, but this does not affect their operation or functionality.
- This user manual was intended to be written as clearly and accurately as possible. However, if you are unclear about anything in this user manual or notice any missing information, please contact us directly.
- We cannot be held responsible for any actions or effects resulting from the execution of any operations outlined in this user manual.

Kett

KETT ELECTRIC LABORATORY

1-8-1 Minami-Magome Ota-Ku, Tokyo 143-8507 Japan

Tel.+81-3-3776-1121 Fax.+81-3-3772-3001

URL <http://www.kett.co.jp/> E-mail overseas@kett.co.jp